



**DMS302
DUAL CYLINDER SCALE**

**INSTALLATION & OPERATION
MANUAL**

DMS302 INFORMATION

GENERAL

The DMS302 is a dual cylinder scale designed specifically for the water and waste water industry. The scale base and weighing surfaces are made of Type 2 PVC plastic and are guaranteed for five years against environmental damage. All mechanical parts wherever possible are made of stainless steel or protected with a durable chemical resistant powder finish.

The DMS302 can accommodate any gas cylinder that does not exceed 12" dia. and 150 lbs. net weight.

SPECIFICATIONS

Accuracy:	±1% F.S.
Resolution:	1 lb.
Scale readability:	1/2 lb.
Scale capacity:	300 lbs.
Safe overload capacity:	400 lbs.

FEATURES

- Simultaneously weighs two cylinders independently and displays the net weight on separate indicators.
- Adjustable cross bar and chains adapt to different size cylinders.
- All scales are assembled, tested and calibrated at the factory.
- Easy to read 5" scale length with 150 graduations that allows for 1/2 lb. readability.

ASSEMBLY

Remove the scale parts from the carton and inspect for shipping damage. Place the post on the floor with the indicator face up and insert the two 6-32 threaded extension rods into the brass bottom stops.

Cut the plastic tie wrap and stand the scale base vertical on its back skirt. Guide the extension rods thru the base and levers while bringing the post and base together. Use the extension rods to pull the brass bottom stops thru the levers and insert the "E" ring. Secure the base to the post with two 5/16 hex bolts and lock washers.

Locate the scale on a reasonably level floor. The circular rings are designed to support the loads. For best performance, use the four holes located in the corners to bolt the scale base to the floor. In order to make the assembly easier, all tension has been removed from the lever springs. Before placing in service, preload the indicator by turning both tare adjust knobs clockwise for approximately seven turns.

OPERATION

Locate a full cylinder in the approximate center of the weighing surface, connect the cylinder chains and make all the required gas connections. Use the tare weight adjust knob to cancel out the tare weight of the gas cylinder. Using the tare adjust knob, set the pointer to the net weight of the cylinder (150 in the case of the standard chlorine cylinders). The displayed weight is now an indication of the weight of product remaining.

WARRANTY

Eagle Microsystems warrants the DMS302 scale base to be free from all defects in material and workmanship. Any parts that fail because of defective workmanship or material within five (5) years of date of shipment will be replaced. The warranty does not include misuse, negligence or modifications.

Eagle Microsystems shall not be liable for transportation or installation charges, or any other expenses incurred by the customer.

DMS302 ASSEMBLY INSTRUCTIONS

The DMS302 Has Been Assembled, Tested & Calibrated, Then Disassembled & packaged for shipment. The Following Steps Are Required For Re-assembly.

REQUIRED ITEMS

A. Threaded Extension Rods (2)



B. Hex Head Bolt - 5/16 - 18 x 2 1/2" & Lock Washer (2)

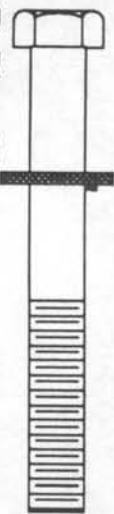

C. "E" Ring (2)

CAUTION

Do Not Stand Post Vertical! Damage To The Steelyard Can Result.

ASSEMBLY STEPS

1. Lay Post On Floor & Screw Threaded Extension Rods Into Brass Bottom Stops.
2. Remove The Plastic Tie Wrap.
3. Stand The Deck On Its Back Skirt.
4. Slide Deck & Post Together, While Using The Extension Rods To Guide The "Brass Bottom Stops" Thru The Levers.

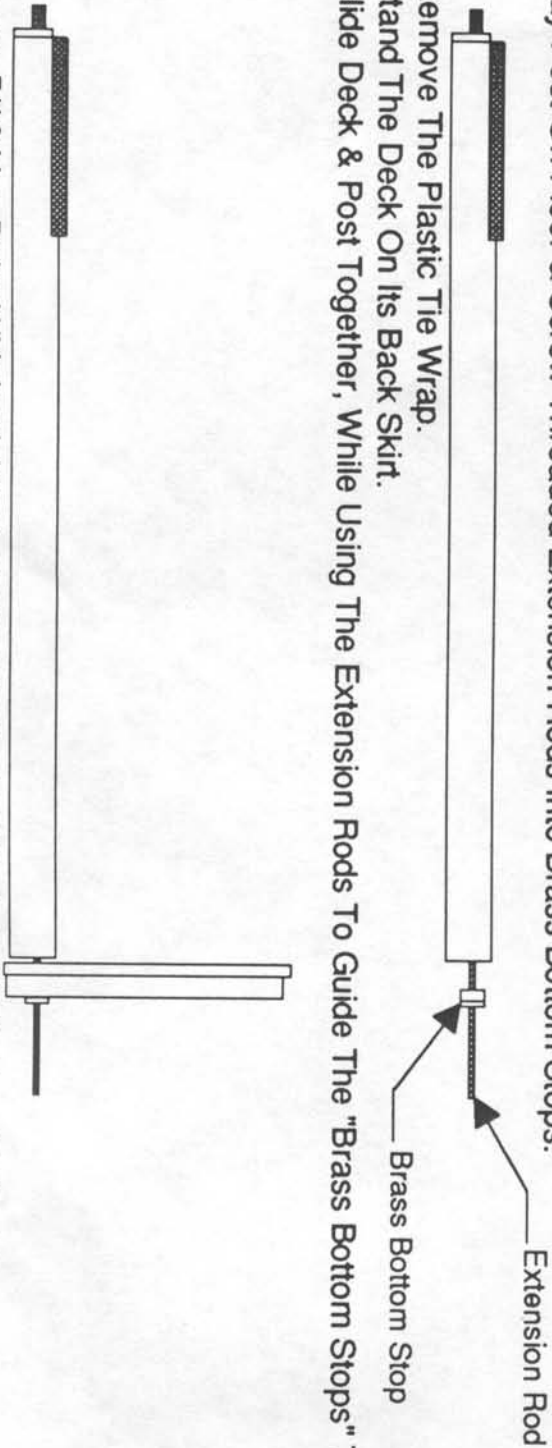

5. Screw 5/16 Hex Bolts With Lock Washers Thru Bottom Of Deck & Into Bottom Of Post.
6. Pull Extension Rods Thru The Lever Holes. Insert E-rings Into Snap Ring Groove, & Let Stops Back Into Lever Holes.
7. Unscrew Extension Rod & Stand Scale Upright.

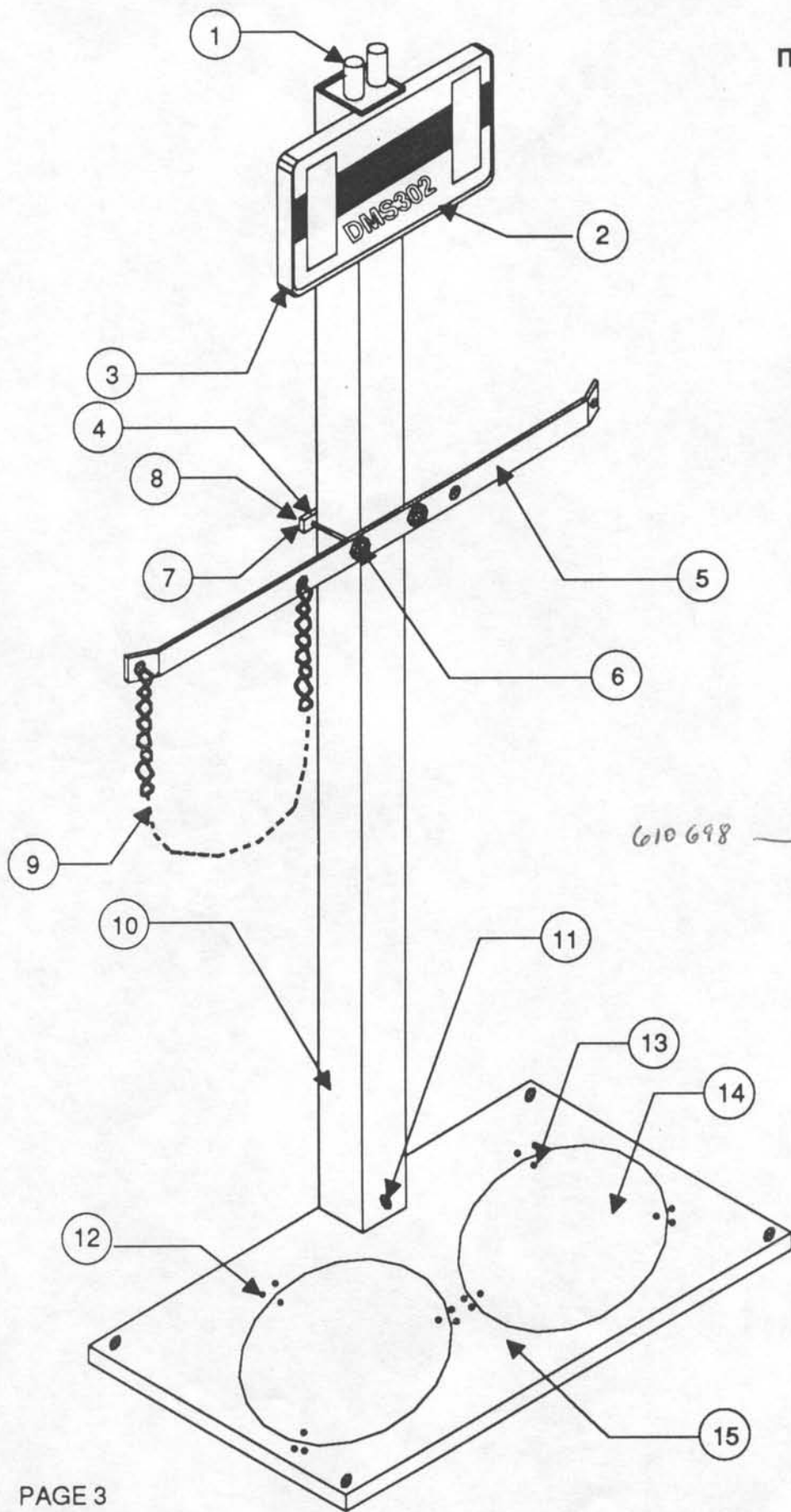

ITEM	DISCRIPTION	P/N	QTY
1	Zero Knob	400316	2
2	Overlay	10015	1
3	Back Plate	400302	1
4	Support Arm Strap	400319	1
5	Support Arm	400320	1
6	5/16-18 x 4 Hex Bolt	613029	2
7	5/16 Hex Nut	613028	2
8	5/16 Lock Washer	613015	2
9	Cylinder Chain	100489	2
10	Post	400307	1
11	Post Clamp	400308	1
12	10B x 5/8 Self Tap	611060	12
13	Pivot Screw	400229	6
14	Disc	400178-1	2
15	Deck	400178	1
16	Stop "E" Ring	613709	2
17	Steelyard Stop	400313	2
18	Steelyard	400140	2
19	Adjusting Nut	610693	2
20	Jam Nut	610632	2
21	Clevis	400312	2
22	Clevis Bushing	400334	2
23	Link	400329	2
24	Tension Spring	400318	2
25	Zero Adj. Link	400315	2
26	Socket Set Screw	610436	4
27	Post Cap	400328	1
28	Link "E" Ring	612101	2
29	Dial Scale	100602	2
30	Pointer Crank Axel	400305	2
31	Pointer "E" Ring	610506	2
32	Pointer	400304	2
33	Axel Bushing	400317	2
34	Pointer Axel	400309	2
35	Lock Nut	611035	2
36	Disk Washer	400154	6
37	Perimeter Flexure	400143	6
38	Perimeter Clamp	400144	6
39	Center Clamp	400145	2
40	Center Flexure	400142	2
41	Short Lever	400160	4
42	Long Lever	400141	2
43	6A-3/8 Self Tap Hex	610684	4
44	10-24 x 3/8 Hex Head	611061	8
45	10B-5/8 Self Tap Phlip	611060	12
46	10A-3/8 Self Tap Hex	611028	8
47	10-32 x 3 1/4 Bolt	611013	3

610698

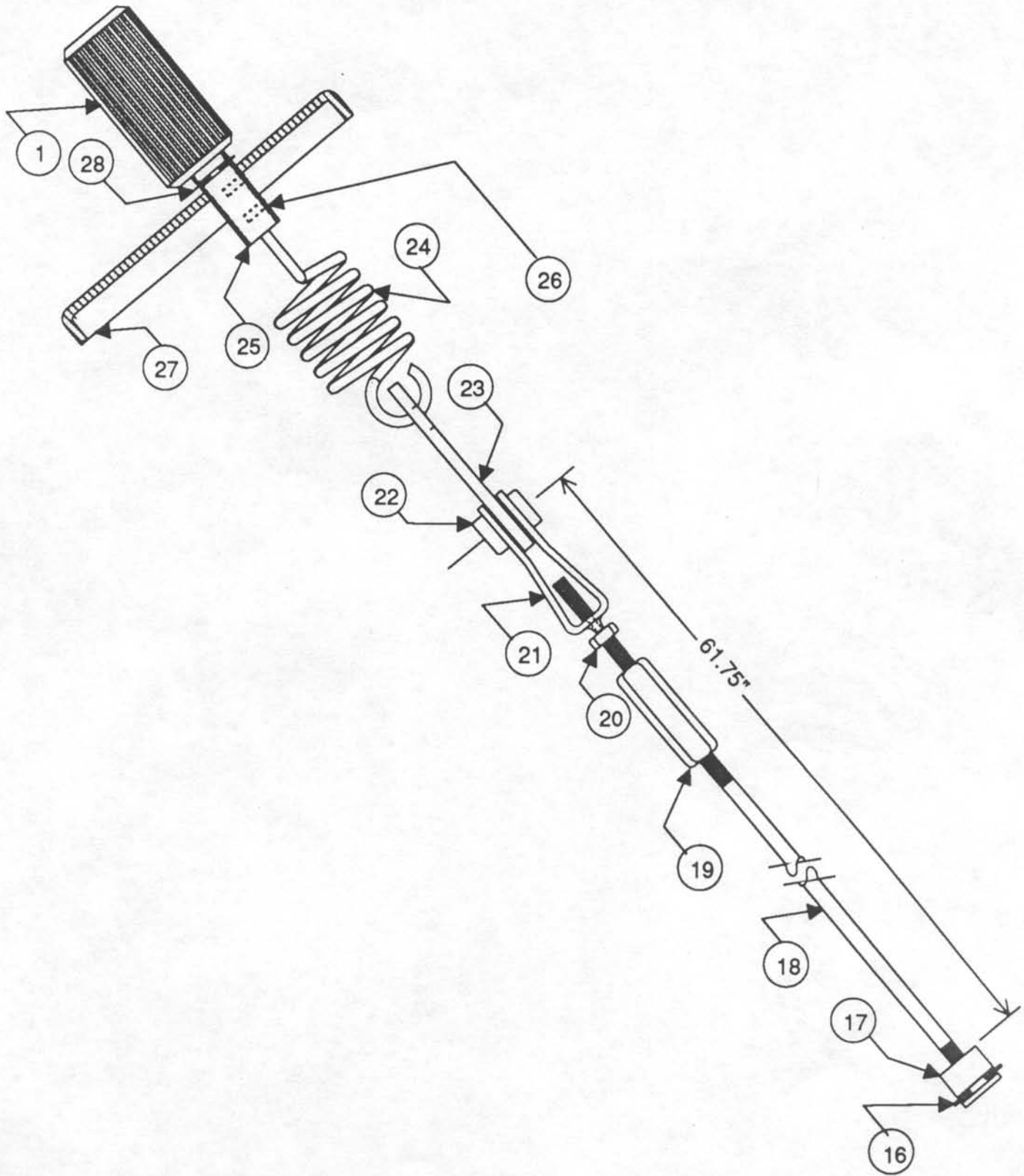

**DMS STEELYARD/CLEVIS
ASSEMBLY**

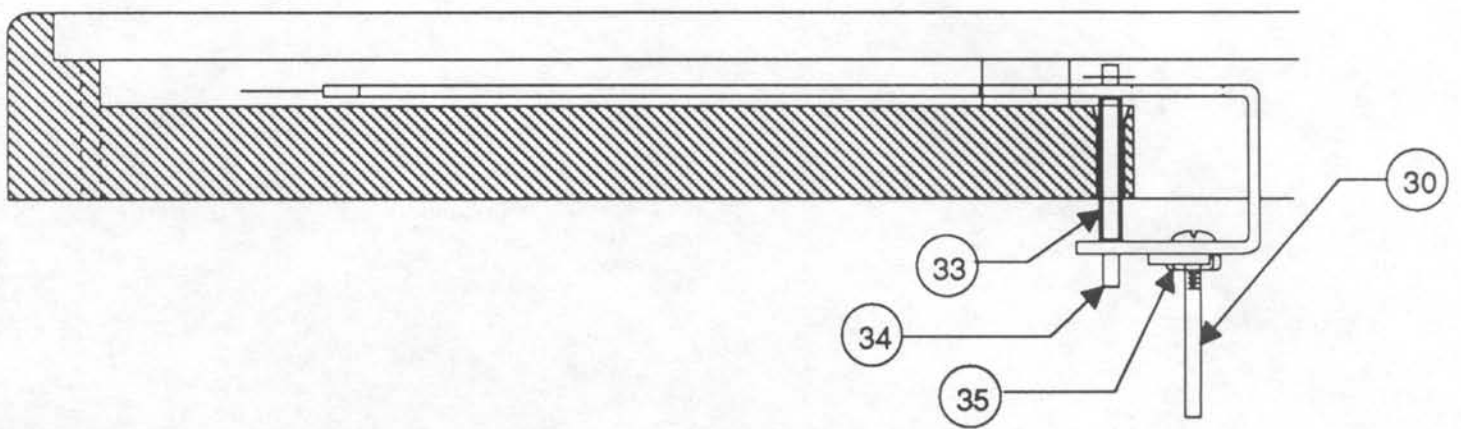
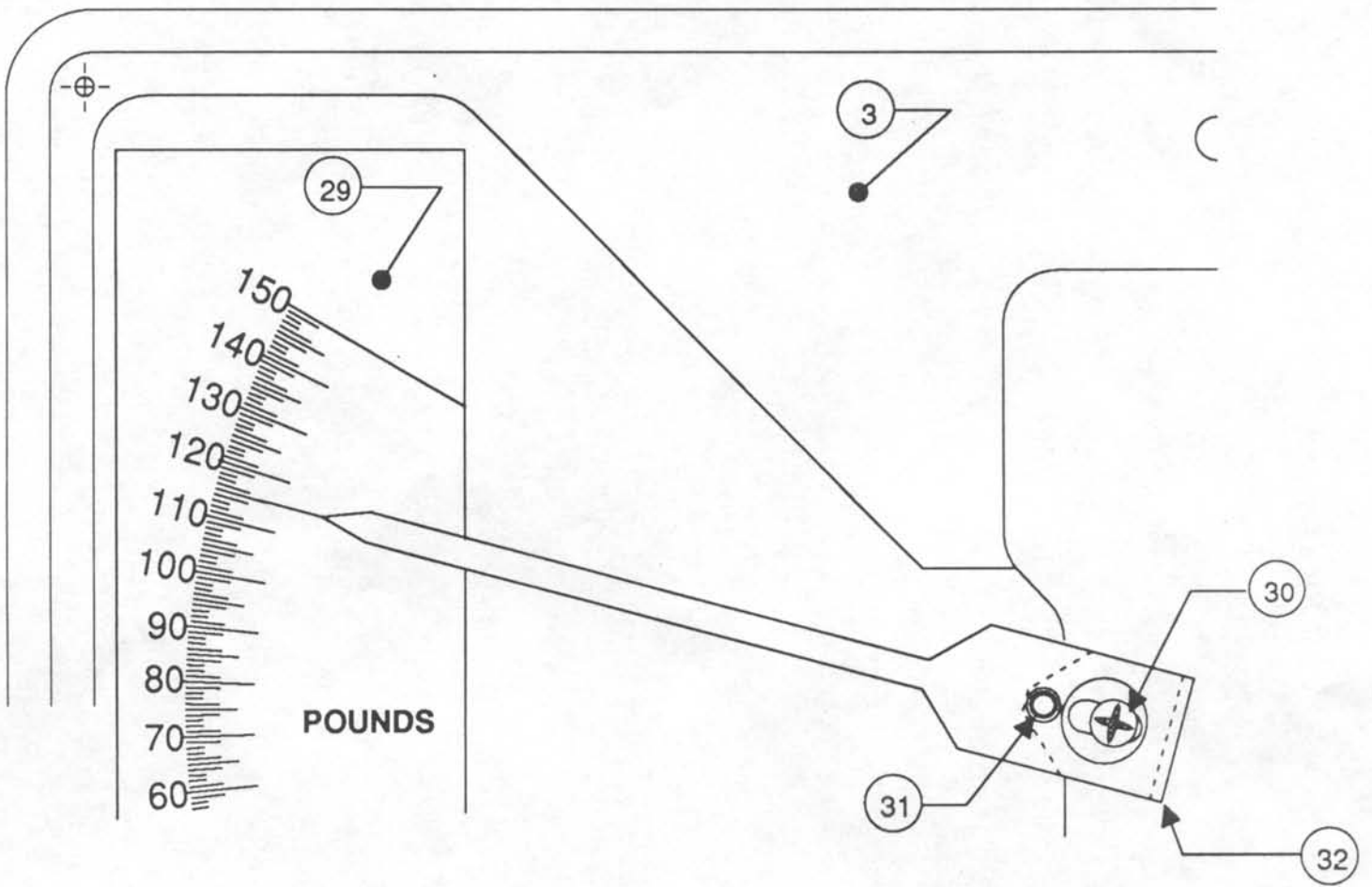

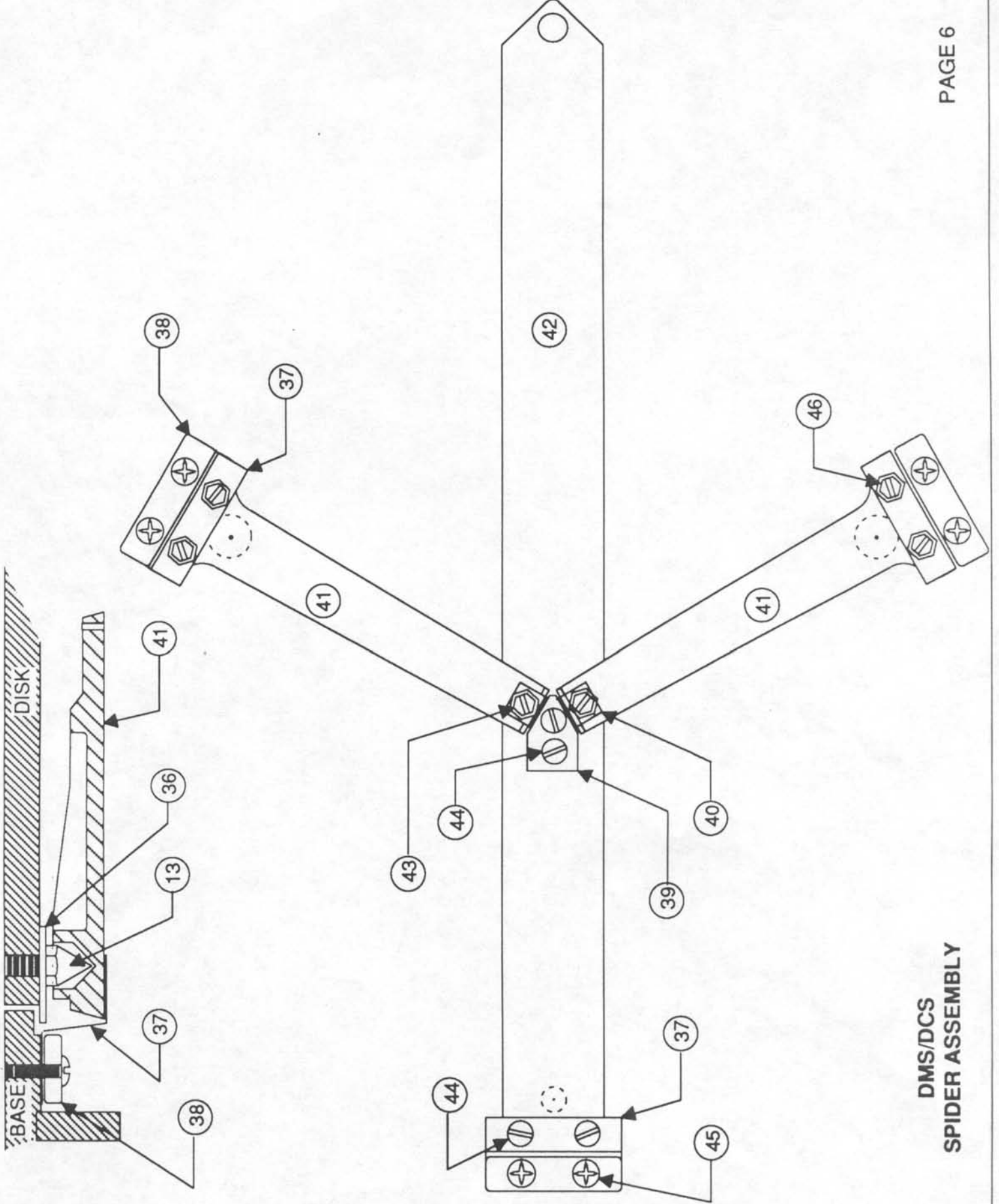

DMS/DCS
SPIDER ASSEMBLY



366 CIRCLE OF PROGRESS

POTTSTOWN, PA 19464

PHONE: 610.323.2250 FAX: 610.323.0114